

Ø25 PVC IRRIGATION CONDUIT  
(HEIGHT VARIES)

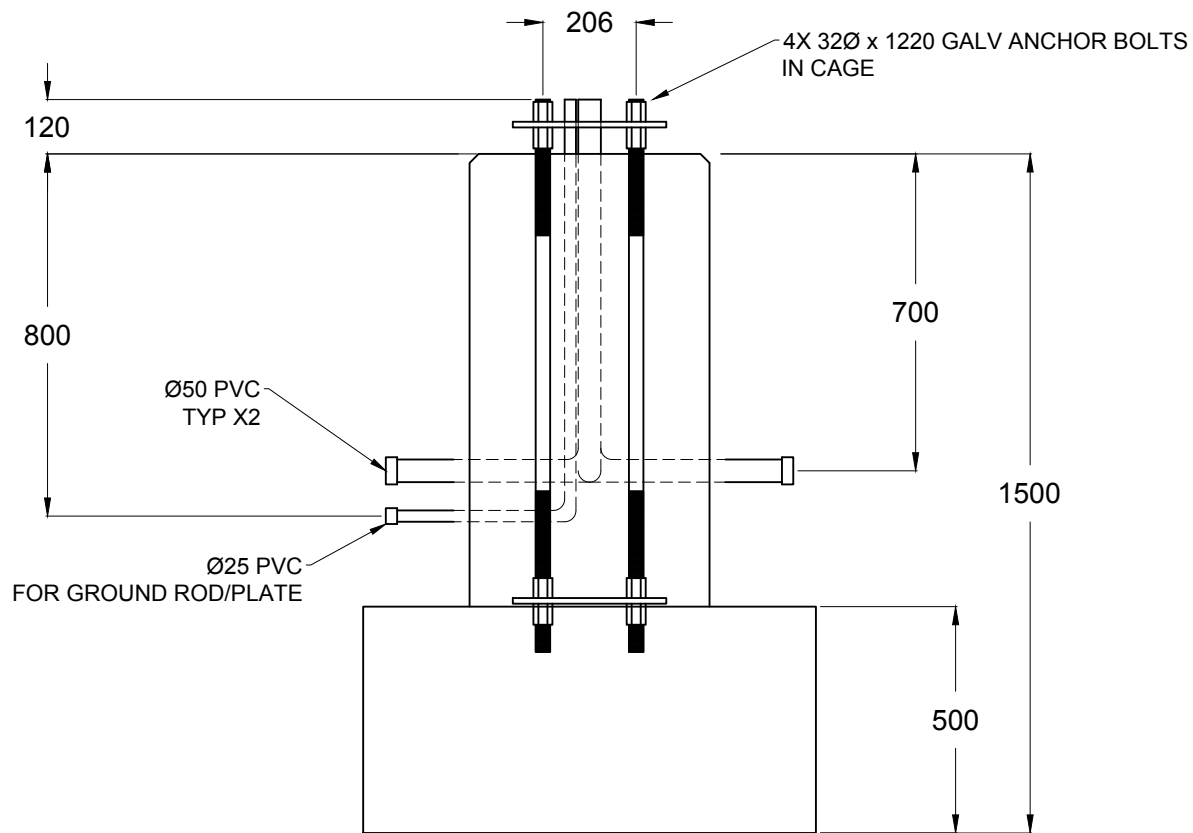
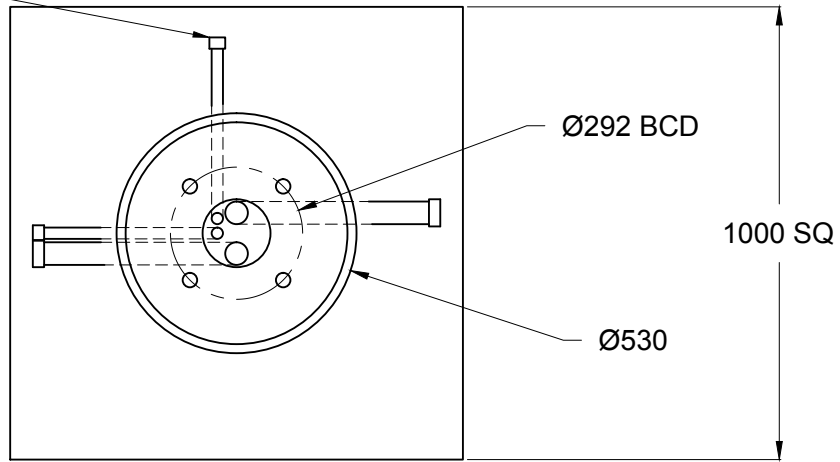

**GENERAL NOTES**

- PRODUCT MANUFACTURED IN ACCORDANCE WITH CSA 23.4
- SITE INSTALLATION, BACKFILLING & SUITABILITY FOR USE IS RESPONSIBILITY OF OTHERS
- MINIMUM CONCRETE STRENGTH: 30 MPa

THIS DRAWING AND ALL INFORMATION, IS & SHALL REMAIN THE PROPERTY OF FRASERWAY PRECAST. ANY USE, ALTERATIONS, OR REPRODUCTIONS WITHOUT WRITTEN CONSENT FROM FRASERWAY PRECAST IS STRICTLY PROHIBITED.

**FRASERWAY PRECAST LTD**

22765 FRASER HIGHWAY  
 LANGLEY, BC V3A 4R6  
 TEL: 604-534-2911 FAX: 604-533-3238  
 EMAIL: INFO@FRASERWAYPRECAST.COM  
 WWW.FRASERWAYPRECAST.COM

**RICHMOND PEDESTAL BASE -  
 TYPE P5**

DRAWN BY: AY	DIMENSIONS IN MILLIMETERS UNLESS OTHERWISE SPECIFIED	DWG #: SB
DATE: 18-Sep-13	TOLERANCES ± 5	P5